

X: MAINSWITCH
 PE: PROTECTIVE GROUND TERMINAL

T01: THERM./MAX. PROTECTION SYSTEM PUMP
 C01: CONTACTOR SYSTEM PUMP
 P01: SYSTEM PUMP

T02: THERM./MAX. PROTECTION FILLING PUMP
 C02: CONTACTOR FILLING PUMP
 P02: FILLING PUMP

Z1: CIRCUIT BREAKER

PS1: POWER SUPPLY AC110-240V / DC24V

PS2: POWER SUPPLY AC230-520V / AC24V

MAINS: 3P230V-N+PE 60Hz
 FUSE MAX: 16 [A]



PROJECTNUMBER: PD15.003	DRAWINGSSCALE: 1 : 1	DRAWINGUNITS: mm	AUTHOR: MB	CREATION DATE: 10/10/2016
PROJECTNAME: HortiMaX Go	AUTHORISED: AddK	REVISION DATE: 09/12/2016		
SUBJECT: CIRCUIT DIAGRAM_1	PAGE: 4 OF 12	STATUS: INTERNAL		
FILENAME: 160314DRA020 044 HortiMaX Go-PRO aqua controller [3P230V-N+PE 60Hz] drawing.vsd				

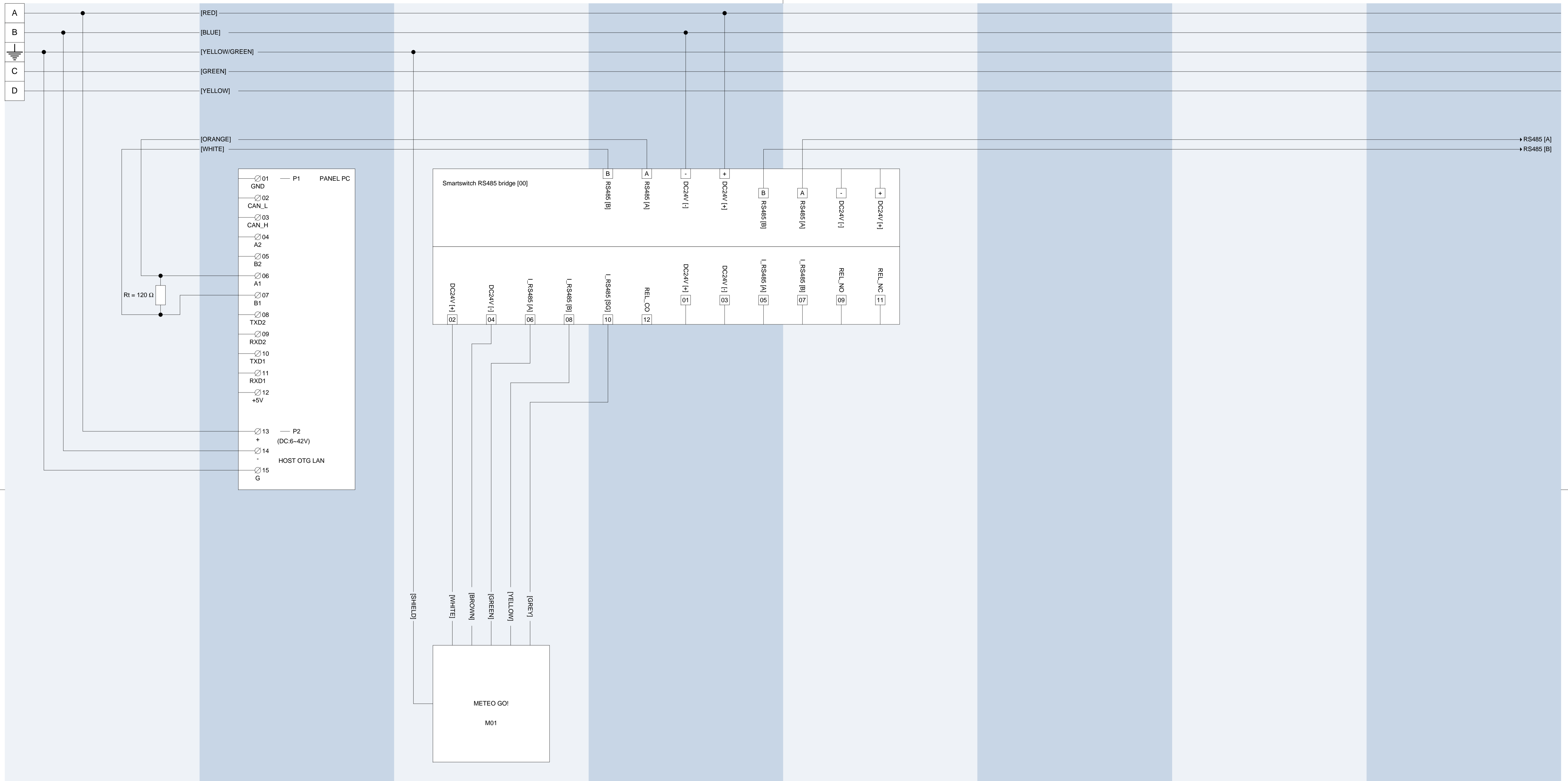

Rt: BUS TERMINATION RESISTOR

M01: METEO STATION



PROJECTNUMBER: PD15.003	DRAWINGSSCALE: 1 : 1	DRAWINGUNITS: mm	AUTHOR: MB	CREATION DATE: 10/10/2016
PROJECTNAME: HortiMaX Go	AUTHORISED: AddK		REVISION DATE: 09/12/2016	
SUBJECT: CIRCUIT DIAGRAM_2	PAGE: 5 OF 12		STATUS: INTERNAL	
FILENAME: 160314DRA020 044 HortiMaX Go-PRO aqua controller [3P230V-N+PE 60Hz] drawing.vsd				

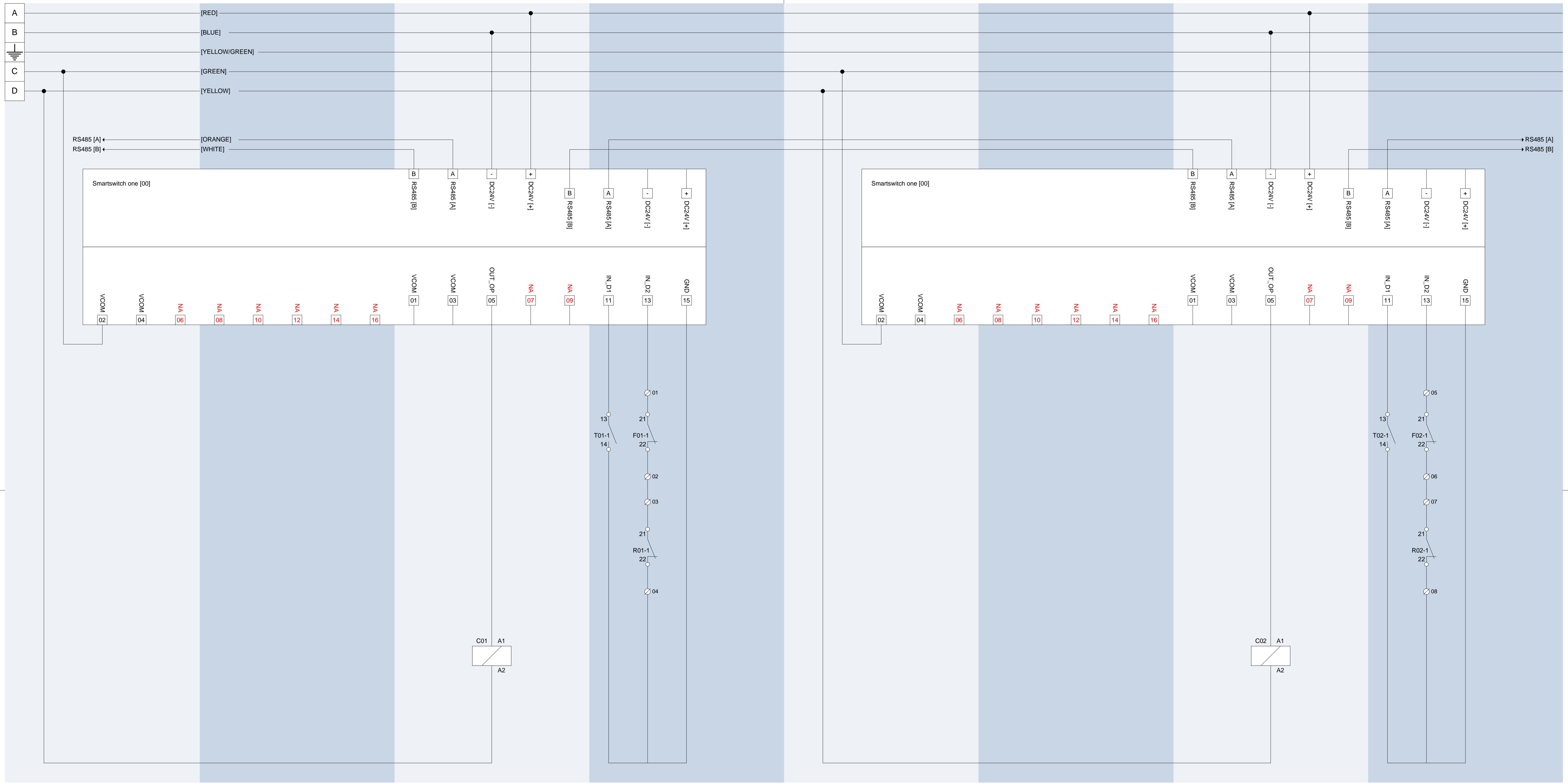

C01: CONTACTOR SYSTEM PUMP

T01-1: THERM./MAX. PROTECTION SYSTEM PUMP
 R01-1: THERMOSTAT SYSTEM PUMP
 F01-1: MINIMUM LEVEL FLOAT SYSTEM PUMP

C02: CONTACTOR FILLING PUMP

T02-1: THERM./MAX. PROTECTION FILLING PUMP
 R02-1: THERMOSTAT FILLING PUMP
 F02-1: MAXIMUM LEVEL FLOAT FILLING PUMP



PROJECTNUMBER: PD15.003	DRAWINGSSCALE: 1 : 1	DRAWINGUNITS: mm	AUTHOR: MB	CREATION DATE: 10/10/2016
PROJECTNAME: HortiMax Go	AUTHORISED: AddK		REVISION DATE: 09/12/2016	
SUBJECT: CIRCUIT DIAGRAM_3	PAGE: 6 OF 12		STATUS: INTERNAL	
FILENAME: 160314DRA020 044 HortiMax Go-PRO aqua controller [3P230V-N+PE 60Hz] drawing.vsd				

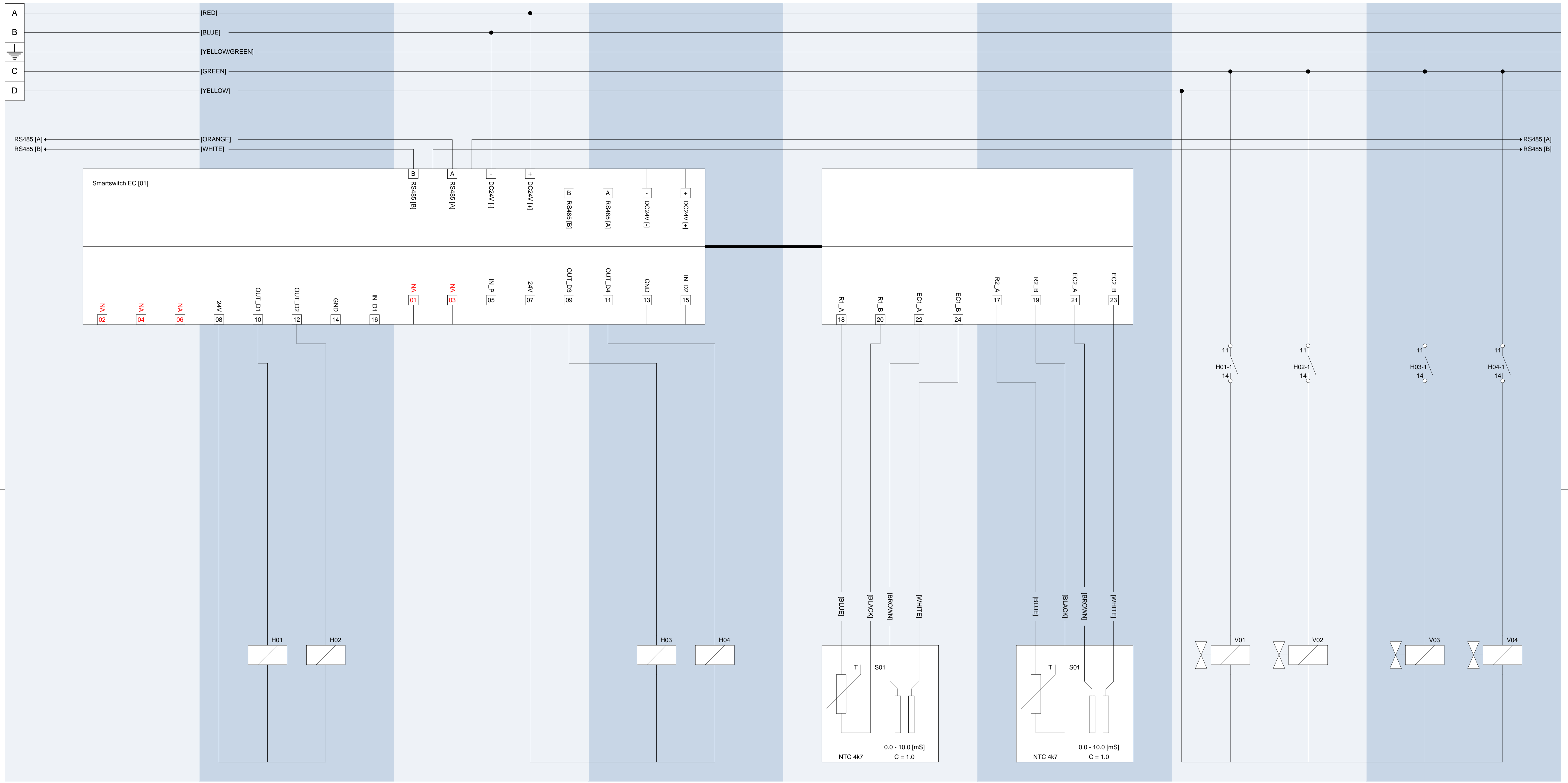

H01: EC DOSAGE VALVE 1
H02: EC DOSAGE VALVE 2

H03: EC DOSAGE VALVE 3
H04: EC DOSAGE VALVE 4

S01: EC SENSOR 1

S02: EC SENSOR 2

H01-1: EC DOSAGE VALVE 1
H02-1: EC DOSAGE VALVE 2

H03-1: EC DOSAGE VALVE 3
H04-1: EC DOSAGE VALVE 4

V01: SOLENOID EC DOSAGE VALVE 1 [FERTILIZER 1]
V02: SOLENOID EC DOSAGE VALVE 2 [FERTILIZER 2]

V03: SOLENOID EC DOSAGE VALVE 3 [FERTILIZER 3]
V04: SOLENOID EC DOSAGE VALVE 4 [FERTILIZER 4]



PROJECTNUMBER: PD15.003	DRAWINGSCALE: 1 : 1	DRAWINGUNITS: mm	AUTHOR: MB	CREATION DATE: 10/10/2016
PROJECTNAME: HortiMaX Go	AUTHORISED: AddK		REVISION DATE: 09/12/2016	
SUBJECT: CIRCUIT DIAGRAM_4	PAGE: 7 OF 12		STATUS: INTERNAL	
FILENAME: 160314DRA020 044 HortiMaX Go-PRO aqua controller [3P230V-N+PE 60Hz] drawing.vsd				

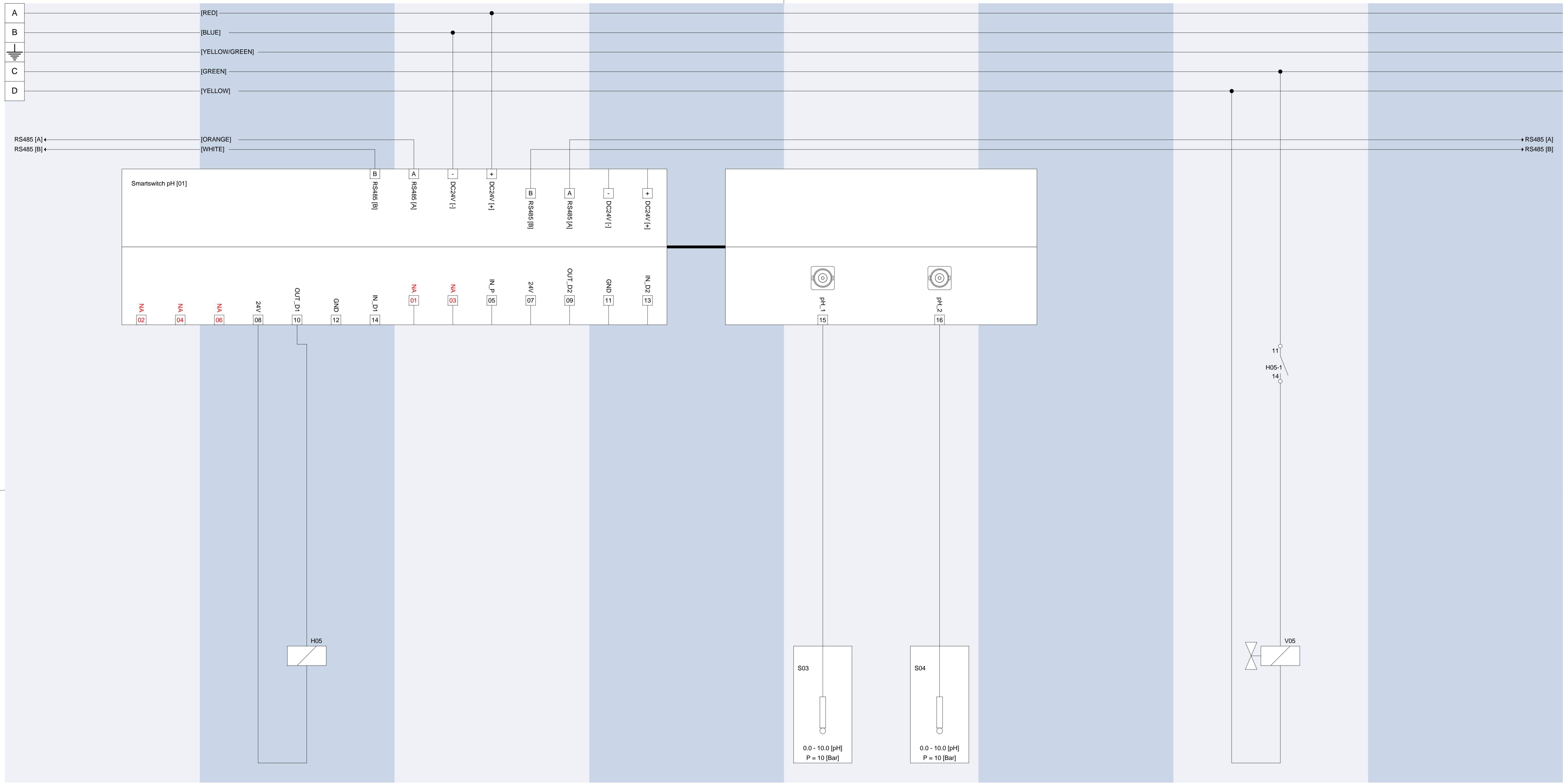

H05: pH DOSAGE VALVE 1

S03: pH SENSOR 1
S04: pH SENSOR 2

H05-1: pH DOSAGE VALVE 1

V05: SOLENOID pH DOSAGE VALVE 1 [ACID]



PROJECTNUMBER: PD15.003	DRAWINGSSCALE: 1 : 1	DRAWINGUNITS: mm	AUTHOR: MB	CREATION DATE: 10/10/2016
PROJECTNAME: HortiMaX Go	AUTHORISED: AddK		REVISION DATE: 09/12/2016	
SUBJECT: CIRCUIT DIAGRAM_4	PAGE: 8 OF 12		STATUS: INTERNAL	
FILENAME: 160314DRA020 044 HortiMaX Go-PRO aqua controller [3P230V-N+PE 60Hz] drawing.vsd				

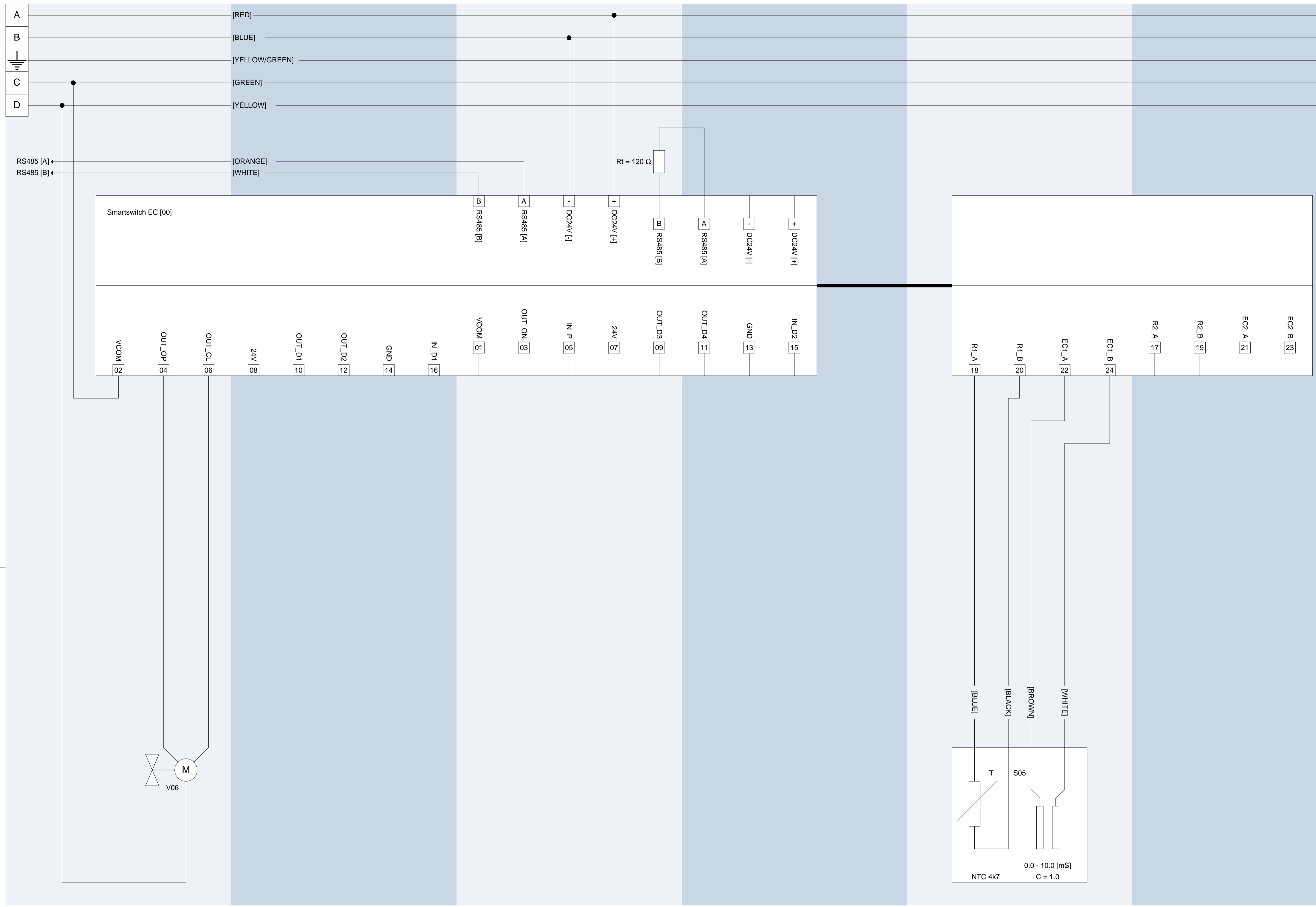

V06: SUPPLY EC MOTOR VALVE

Rt: BUS TERMINATION RESISTOR

S05: EC SENSOR 3



PROJECTNUMBER: PD15.003	DRAWINGSSCALE: 1 : 1	DRAWINGUNITS: mm	AUTHOR: MB	CREATION DATE: 10/10/2016
PROJECTNAME: HortiMaX Go	AUTHORISED: AddK		REVISION DATE: 09/12/2016	
SUBJECT: CIRCUIT DIAGRAM_4	PAGE: 9 OF 12		STATUS: INTERNAL	
FILENAME: 160314DRA020 044 HortiMaX Go-PRO aqua controller [3P230V-N+PE 60Hz] drawing.vsd				

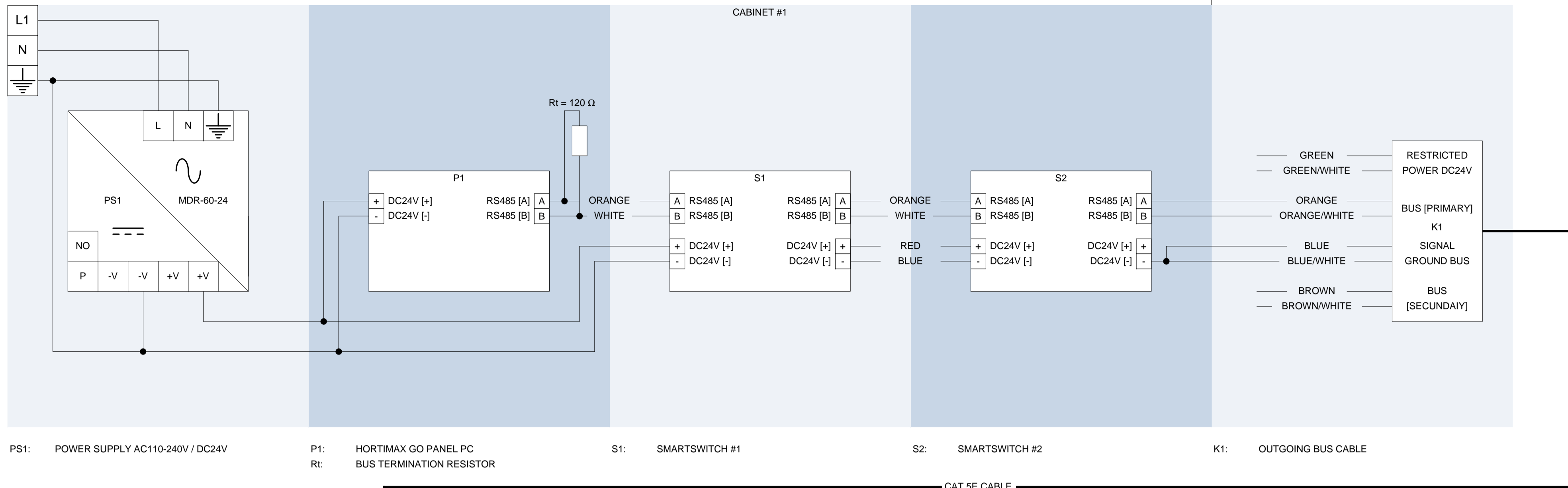

PS1: POWER SUPPLY AC110-240V / DC24V
 P1: HORTIMAX GO PANEL PC
 Rt: BUS TERMINATION RESISTOR
 S1: SMARTSWITCH #1
 S2: SMARTSWITCH #2
 K1: OUTGOING BUS CABLE

- The applied bus cable has to be CAT 5E or better.
- The applied bus cable has a specific impedance, Z_0 of 100 [Ω]
- It is preferable that the applied bus cable is mechanically enhanced.
- On the bus cable no stubs should occur.
- The maximum number of Smartswitches on the RS485 bus is 32, that are 33 devices including the Touchscreen Panel PC.
- The bus cable has to be terminated on both outer ends by means of a bus termination resistor of 120 [Ω].
- The maximum bus cable length is 500 [m].

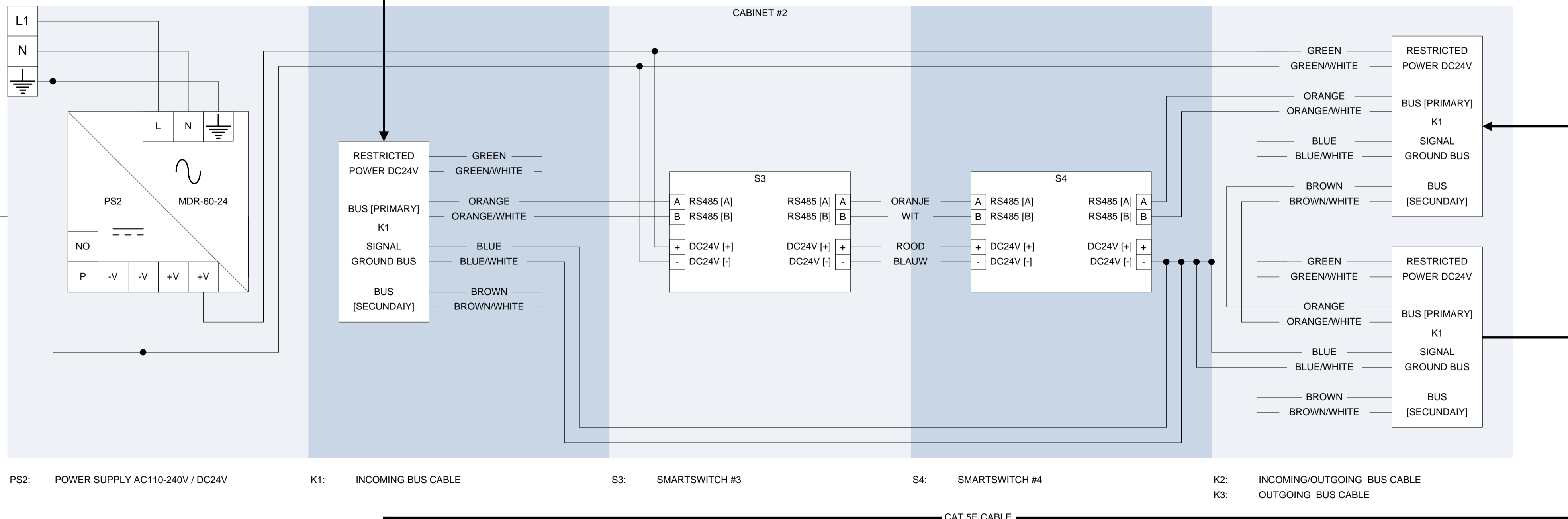

PS2: POWER SUPPLY AC110-240V / DC24V
 K1: INCOMING BUS CABLE
 S3: SMARTSWITCH #3
 S4: SMARTSWITCH #4
 K2: INCOMING/OUTGOING BUS CABLE
 K3: OUTGOING BUS CABLE
 S5: SMARTSWITCH #5

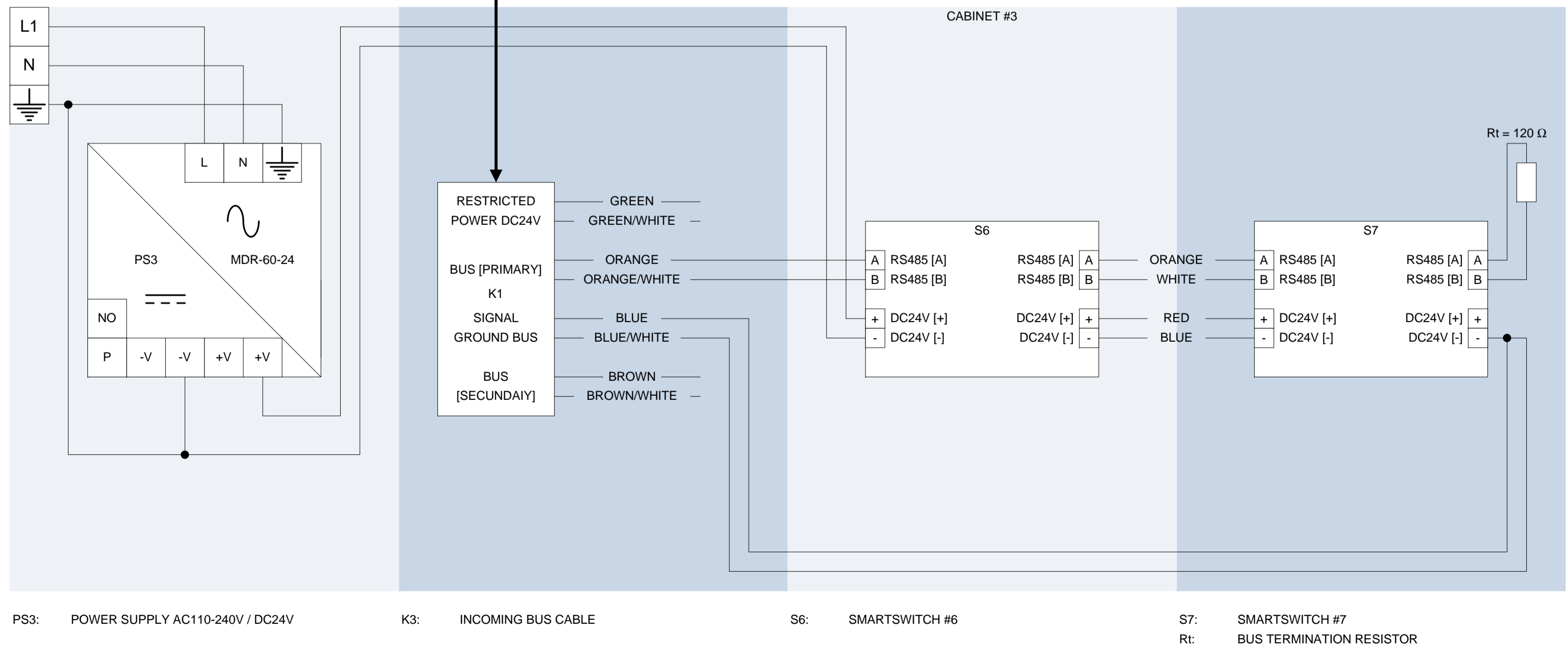

PS3: POWER SUPPLY AC110-240V / DC24V
 K3: INCOMING BUS CABLE
 S6: SMARTSWITCH #6
 S7: SMARTSWITCH #7
 Rt: BUS TERMINATION RESISTOR

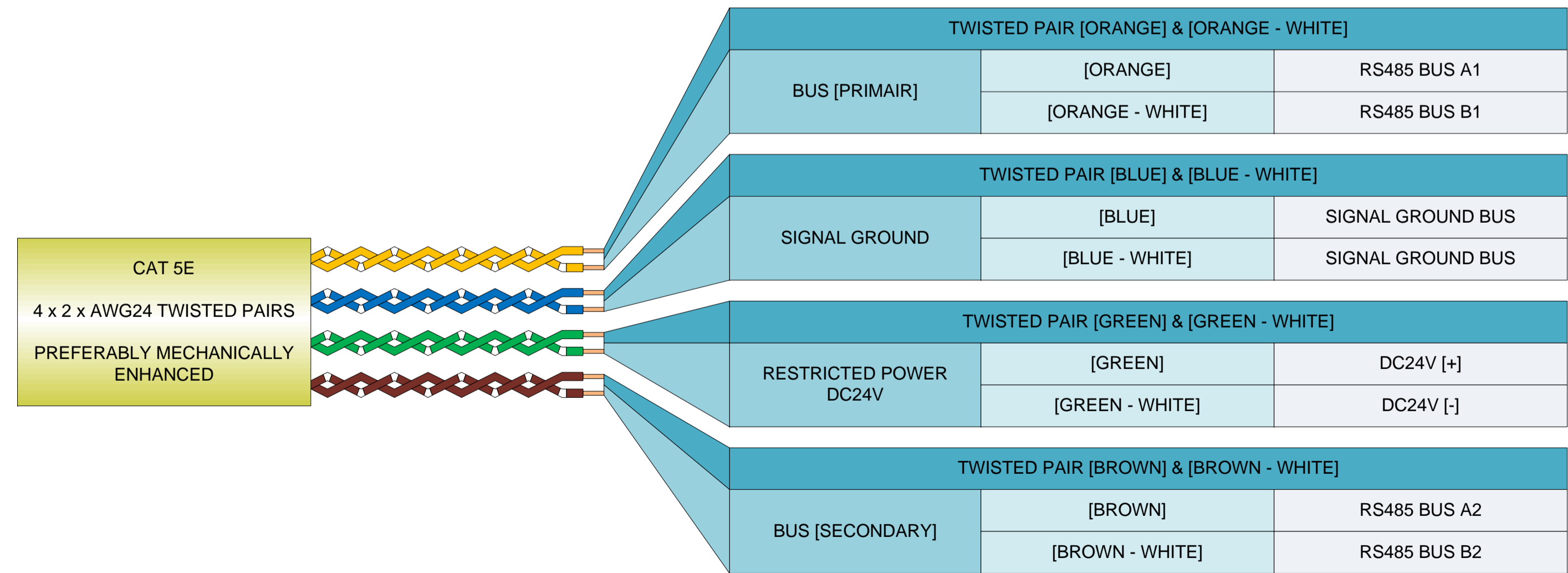

PROJECTNUMBER: PD15.003	DRAWINGSSCALE: 1 : 1	DRAWINGUNITS: mm	AUTHOR: MB	CREATION DATE: 10/10/2016
PROJECTNAME: HortiMax Go	AUTHORISED: AddK	REVISION DATE: 09/12/2016		
SUBJECT: NETWORK TOPOLOGY	PAGE: 10 OF 12	STATUS: INTERNAL		
FILENAME: 160314DRA020 044 HortiMax Go-PRO aqua controller [3P230V-N+PE 60Hz] drawing.vsd				